

*Læs denne brugsanvisning før du betjener pistolen.
Read this manual before operate your tool.*

Brugsanvisning

Instruction Manual

TJEP 80/16

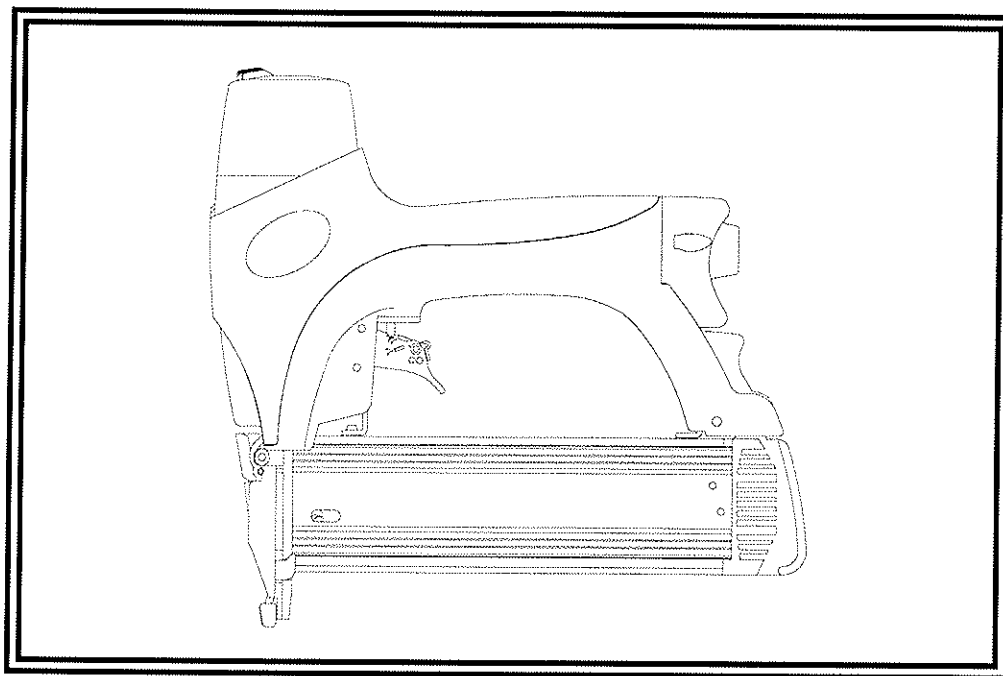

Kontakt din autoriserede forhandler for yderligere information.

Contact your authorized dealer, distributor for further information.



UNIMERCO FASTENING A/S
DK-7451 Sunds
Telefon+45 97 14 14 11 Fax+45 97 14 14 86
E-mail:fastening@unimerco.dk

INDHOLDSFORTEGNELSE

Sikkerhedsbestemmelser	1
Betjeningsvejledning	6
Vedligehold	9
Fejlsøgning	10
Tekniske data	12

CONTENTS

Safety Warnings	1
Tool Use	6
Maintenance	9
Troubleshooting	10
Specifications	12

- **Du skal læse denne brugsanvisning omhyggeligt. Brug eventuelt reservedelstegningen som hjælp. Kontakt din forhandler, hvis du har brug for flere informationer.**
- **Operator must read this manual carefully. Follow instructions in this manual for safety and proper operation.**

Sikkerhedsbestemmelser • Safety Warnings

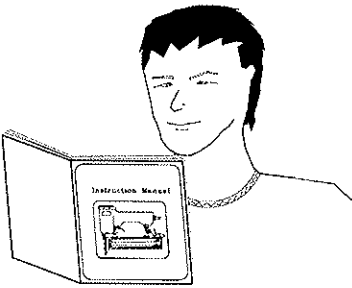
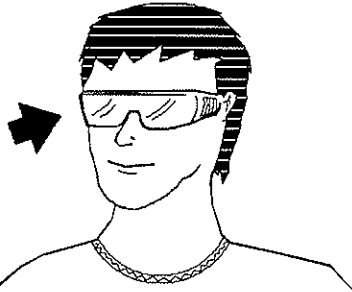
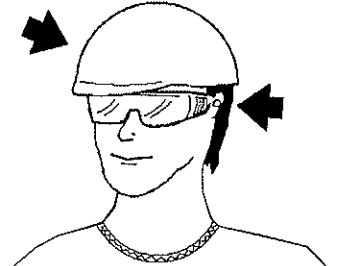
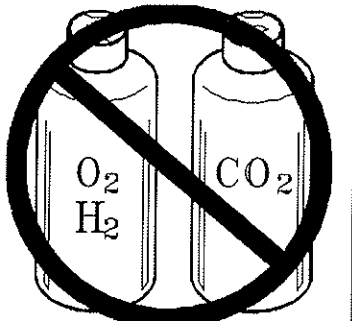
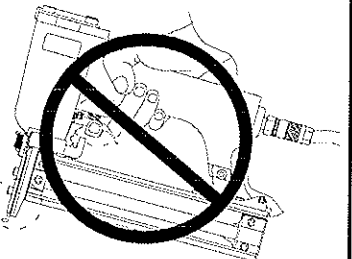
<ul style="list-style-type: none">• For at undgå at komme til skade under brugen af pistolen, skal du læse denne brugsanvisning omhyggeligt. Følg anvisningerne i brugsanvisningen omkring brugen af pistolen, om vedligehold og om fejlsøgning. prevent injuries to yourself and bystanders, refer to tool use, maintenance and troubleshooting sections for additional informations• To prevent injuries to yourself and bystanders, refer to tool use, maintenance and troubleshooting sections for additional informations	 A line drawing of a man's head and shoulders. He is looking down at an open book or manual he is holding. The book has a picture of a tool on its cover and the word 'Instruction' is visible on the page.
<ul style="list-style-type: none">• For at undgå øjenskader skal der bruges beskyttelsesbriller. Brillerne skal også dække siden af ansigtet. Du skal sikre dig at de, der opholder sig omkring arbejdsstedet, også bærer beskyttelsesbriller.• To prevent eye injuries, always wear safety glasses with hard plastic side shields. Be sure everyone in your work area is wearing the same type of safety glasses.	 A line drawing of a man's head and shoulders. He is wearing safety glasses with side shields. Two black arrows point towards the side shields, indicating they should be present.
<ul style="list-style-type: none">• Brug høreværn og beskyttelseshjælm. Hjælmen skal være lavet af hårdt materiale.• Always wear hearing protection and hard hat	 A line drawing of a man's head and shoulders. He is wearing a hard hat and safety glasses with side shields. Two black arrows point towards the side shields, indicating they should be present.
<ul style="list-style-type: none">• Brug aldrig brint, ilt, kuldioxid eller anden flaskegas som drivmiddel til pistolen. Pistolen kan eksplodere, og der kan ske alvorlige skader.• Never use hydrogen oxygen, carbon dioxide or any other bottled gas as a power source for this tool, the tool will explode and cause serious injury.	 A line drawing of two gas cylinders. The left one is labeled 'O2' and 'H2', and the right one is labeled 'CO2'. A large black circle with a diagonal slash through it is superimposed over the cylinders, indicating that these gases should not be used.
<ul style="list-style-type: none">• Flyt fingeren væk fra aftrækkeren når pistolen ikke er i brug. Transportér aldrig pistolen med en finger på aftrækkeren. Rammer næsesikringen noget, vil der blive afskudt en klamme eller et søm.• Remove finger from trigger when not driving fasteners. Never carry tool with finger on trigger, tool will eject fastener if safety is bumped.	 A line drawing of a tool with a finger placed on the trigger. A large black circle with a diagonal slash through it is superimposed over the tool, indicating that the finger should not be on the trigger.

Sikkerhedsbestemmelser • Safety Warnings

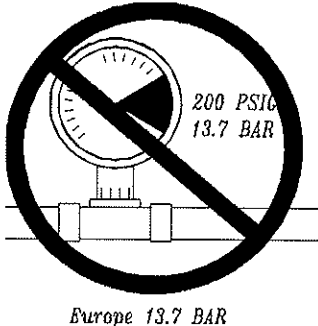
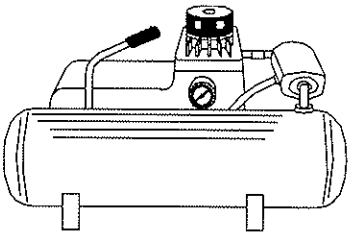
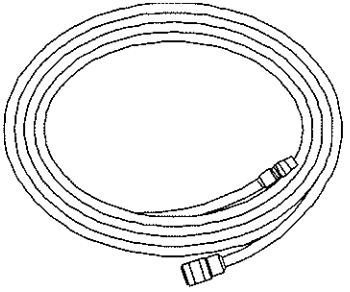
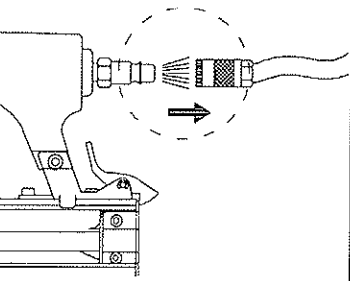
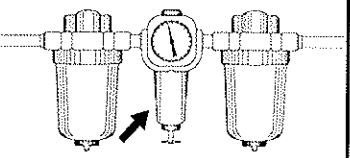
<ul style="list-style-type: none"> • Tilslut aldrig trykluft med et tryk, som overstiger 7hvh. 8 bar (se mærkat på pistol). • Never connect tool to an air hose with pressure exceeds 7 resp. 8 BAR (see label on tool.) 	 <p>200 PSIG 13.7 BAR</p> <p>Europe 13.7 BAR</p>
<ul style="list-style-type: none"> • Luftkompressorer skal opfylde kravene i ANSI B 19.3 1981 (U.S.), "Sikkerhedsstandard for industrielle kompressorer." • Air compressors must comply with requirement ANSI B 19.3 1981 (U.S.), "Safety Standard For Compressors For Process Industries." 	
<ul style="list-style-type: none"> • Luftslangen skal være godkendt til et arbejdstryk på minimum 10.3 BAR eller 150% af det tryk, som kompressoren leverer. • Air hose minimum working pressure rating of 150 psig (10.3 BAR) or 150% of the maximum pressure produced in the system is absolutely necessary. 	
<ul style="list-style-type: none"> • Luftkoblingen på pistolen og på trykluftslangen skal fungere sådan, at trykluft forsvinder fra pistolen, når trykluftslangen afmonteres. • The tool and air supply hose must have a hose coupling such that all pressure is removed from the tool when the coupling joint is disconnected. 	
<ul style="list-style-type: none"> • Brug kun trykluft fra anlæg med dræn, manometer og oliefigter. • Use only compressed air coming through 3 pieces set. 	

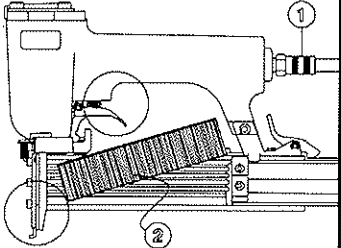
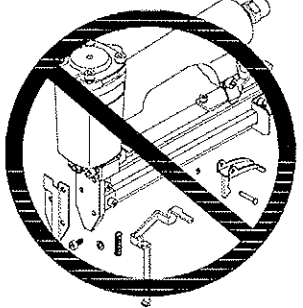
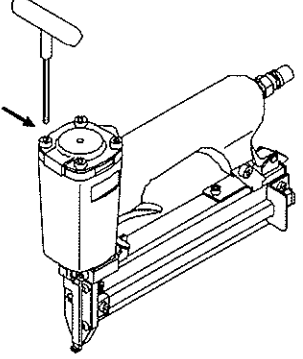
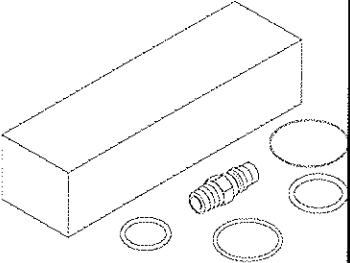
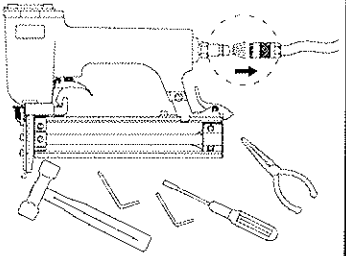

Sikkerhedsbestemmelser • Safety Warnings

<ul style="list-style-type: none">• Slut pistolen til trykluft inden magasinet lades.• Never load fasteners before tool connected to air supply.	
<ul style="list-style-type: none">• Brug aldrig pistolen hvis sikring, aftrækker, eller fjedre har mistet deres function, hvis de mangler eller er beskadigede. Fjern sikring, aftrækker eller fjeder.• Never use tool if safety element, trigger or springs have become inoperative, missing or damaged. It is hazardous to remove safety element, trigger or spring.	
<ul style="list-style-type: none">• Før pistolen anvendes, skal det sikres, at aftrækker, skruer og dæksel sidder forvarligt fast.• Before using this tool, make sure trigger, screw and cap are securely tightened.	
<ul style="list-style-type: none">• Der må ikke laves tekniske ændringer på pistolen.• Do not modify tool without authorization.	
<ul style="list-style-type: none">• Trykluft skal frakobles, når pistolen ikke anvendes, Fjern trykluftslangen.• Disconnect tool from air whenever the tool stop working.	

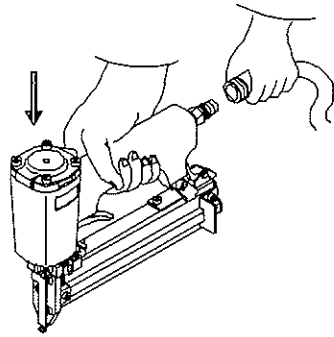
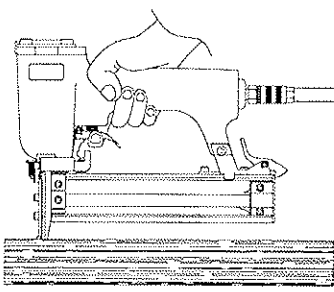
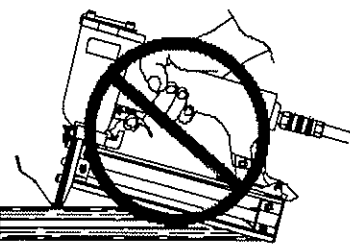
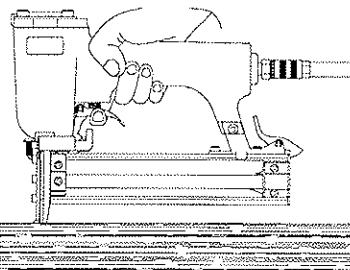
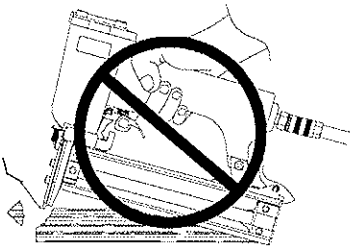
Sikkerhedsbestemmelser • Safety Warnings

<ul style="list-style-type: none"> • Ret aldrig pistolen mod dig selv eller andre. • Keep the tool pointed away from yourself and others. 	
<ul style="list-style-type: none"> • Anvend kun pistolen til træ. Brug ikke pistolen i hårdt materiale. • Fire fasteners into work surface only, never into materials too hard to penetrate. 	
<ul style="list-style-type: none"> • Skyd ikke søm/klammer oveni andre søm/klammer. Pistolen skal altid pege direkte ned mod træet. • Do not drive fasteners on top of other fasteners. Tool fired in an inclined angle is also forbidden. 	
<ul style="list-style-type: none"> • Før aldrig pistolen hen over emnet, mens sikringen er trykket ind. • Do not push safety element on work surface until a second fastener is desired. 	
<ul style="list-style-type: none"> • Skyd ikke nær kanten af emnet. Her kan træet let splinters og søm eller klammer kan slynges ud i luften. • Do not drive fasteners close to the edge of the work surface. The workpiece is likely to split and the fastener could fly free and hit someone. 	

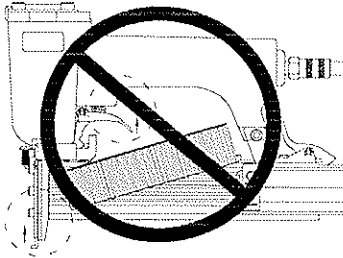
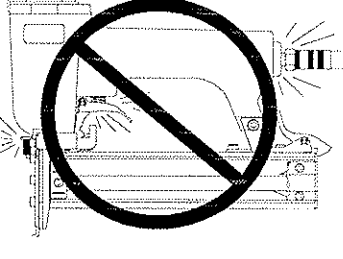
Sikkerhedsbestemmelser • Safety Warnings

<ul style="list-style-type: none"> • Magasinet må aldrig oplades, hvis aftrækkeren er trukket eller sikringen er påvirket. • Do not load fasteners with trigger or safety element depressed. 	
<ul style="list-style-type: none"> • Anvend ikke pistolen, hvis advarselsskiltene er faldet af. • Do not use tool without Danger label on tool. 	<div style="border: 1px solid black; padding: 5px;"> <p style="text-align: center;">CAUTION</p> <ul style="list-style-type: none"> • Always wear safety glasses when operating the nailer. • Do not point the nail discharge outlet at yourself or any one else. • Always disconnect the air chuck when the nailer is not in use, or when adjusting, repairing, or loading the nailer. • Do not use the nailer when the operating pressure exceeds 7kg/cm² • Never operate the nailer near any inflammable substance. • Do not use any power source except an air compressor. </div>
<ul style="list-style-type: none"> • Anvend ikke pistolen, hvis den lækker trykluft eller er beskadiget. • Never use a tool that leaks air or needs repair. 	
<ul style="list-style-type: none"> • Sørg for en sikker arbejdsstilling, når du bruger pistolen. • Be sure you are in a balanced position when using or handling the tool. 	
<ul style="list-style-type: none"> • Anvend kun pistolen med korrekt indstillet trykluft. • Operate tool at recommended pressure. 	

Betjeningsvejledning • Tool Use

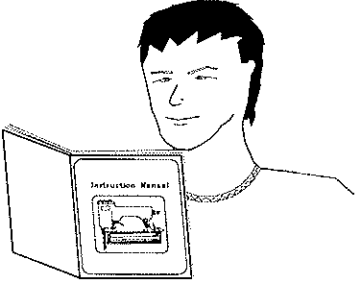
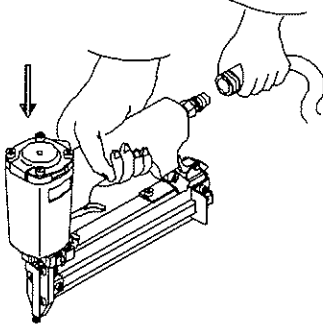
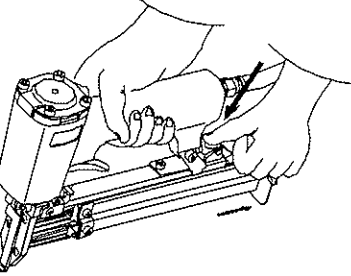
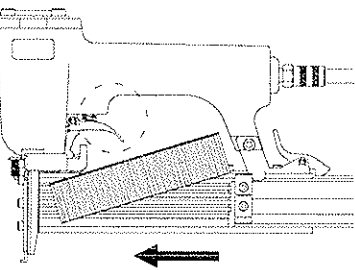
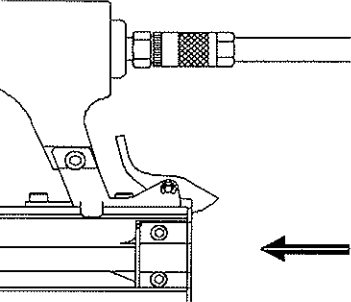
<ul style="list-style-type: none"> • Læs "Sikkerhedsbestemmelserne" inden pistolen tages i brug. • Read "Safety Warnings" before using tool. 	
<ul style="list-style-type: none"> • Lad pistolen pege væk fra dig selv og andre, og tilslut trykluft. • Keep tool pointed away from yourself and others and connect air to tool. 	
<ul style="list-style-type: none"> • Pistolen åbnes ved at udløse magasin-låsen og trække magasin-glideren bagud. • Push click lever and slide upper magazine to open magazine. 	
<ul style="list-style-type: none"> • Læg søm eller klammer i magasinet. Aftrækkeren og sikringen må ikke påvirkes, mens magasinet lades. • Place strip of fasteners into magazine. Do not load with trigger depressed. 	
<ul style="list-style-type: none"> • Skub magasin-glideren fremad til magasin-låsen går i indgreb. • Push upper magazine back until click lever latches. 	

Betjeningsvejledning • Tool Use

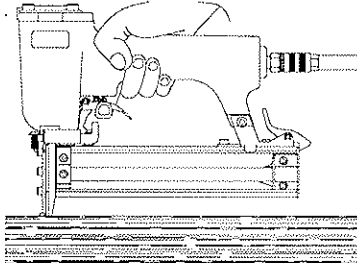
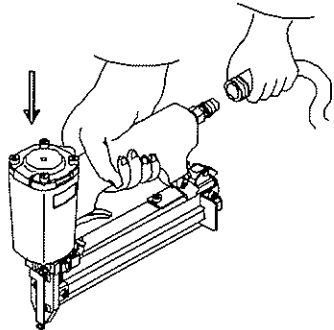
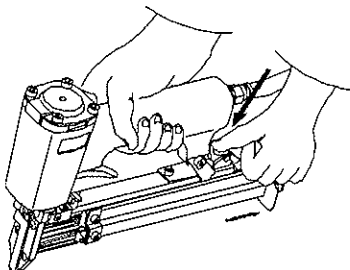
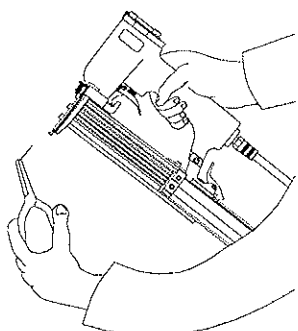
<ul style="list-style-type: none"> • Pres sikringen mod det sted, hvor klammen/sØmmet skal placere, og tryk på aftrækkeren. • Position safety against work surface and pull the trigger. 	
<ul style="list-style-type: none"> • Sætter der sig en klamme eller et sØm fast i pistolen, skal trykluft frakobles. • Disconnect air supply in case fastener jammed. 	
<ul style="list-style-type: none"> • Åbn magasinet ved at udlØse magasin-låsen og træk magasin-gliden tilbage. Fjern klammer eller sØm. • Push click lever and slide upper magazine to open magazine. Remove fasteners. 	
<ul style="list-style-type: none"> • Fjern fastsiddende sØm eller klammer fra pistolens næse. • Remove jammed fastener. 	

- Lad pistolen pege væk fra dig selv og andre, og tilslut trykluft.

- Keep the tool pointed away from yourself and others and connect air to tool.

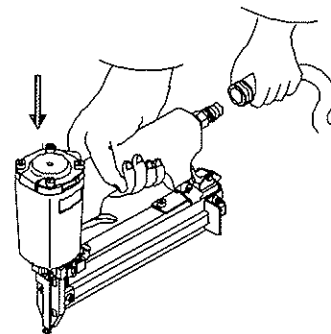

7

Betjeningsvejledning • Tool Use

- Læg søm eller klammer i magasinet. Aftrækkeren og sikringen må ikke påvirkes, mens magasinet lades.

- Place strip of fasteners into magazine with points resting on fastener guide. Do not load with trigger depressed.

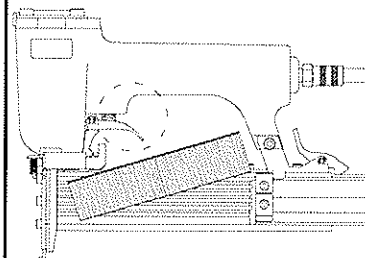

- Skub magasin-glideren fremad til magasin-låsen går i indgreb.

- Push upper magazine back until click lever latches.

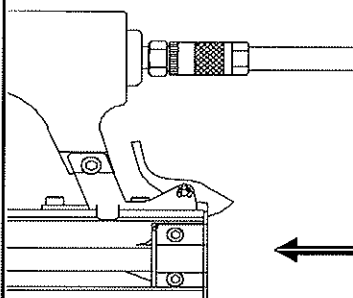

Vedligehold • Mantenimiento

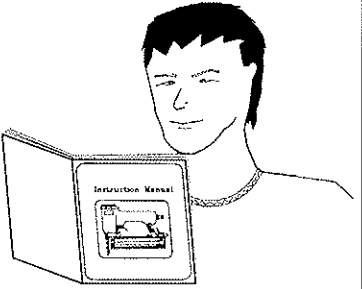
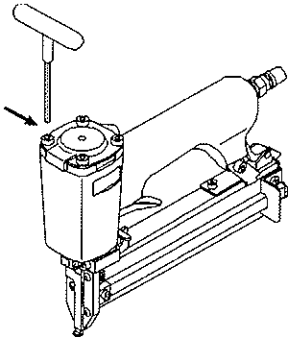
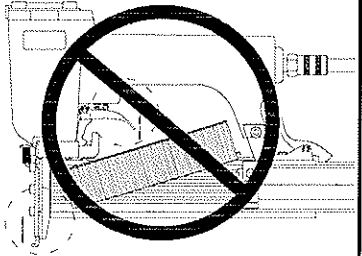
<ul style="list-style-type: none"> • Læs "Sikkerhedsbestemmelserne" inden pistolen vedligeholdes. • Read section titled "Safety Warnings" before maintaining tool. 	
<ul style="list-style-type: none"> • Kontroller at alle skruer er forsvarligt spændte. Er skruerne ikke spændt kan pistolen blive beskadiget og kan ikke betjenes sikkert. • Make sure all screws are kept tight, otherwise unsafe operation and parts breakage might occur. 	
<ul style="list-style-type: none"> • Inden du bruger pistolen og inden trykluft tilkobles, skal du kontrollere, at sikring og aftrækker kan bevæge sig frit og ikke er beskadiget. • Do not use tool if safety element or trigger sticks or binds. Make daily inspection with tool disconnected. 	

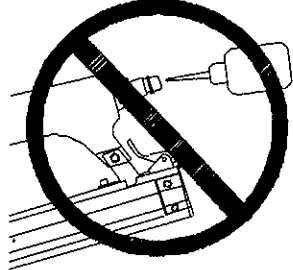
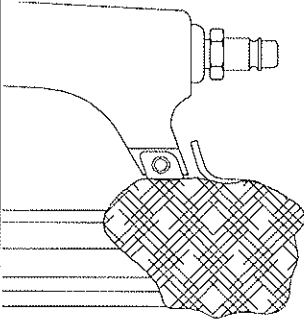
<ul style="list-style-type: none"> • Smør kun pistolen, når det er nødvendigt. Brug kun trykluftværktøjsolie. • Lubricate tool when it is necessary. 	
<ul style="list-style-type: none"> • Inden du bruger pistolen, skal du kontrollere, at den ikke har ydre skader. Er pistolen beskadiget, må du ikke bruge den. Børst pistolen ren hver dag. Brug ikke brandbart rengøringsmiddel til at rengøre pistolen med. Dyp ikke pistolen i vand. Dette kan ødelægge o-ringe og andre indre dele. • Wipe tool clean daily and inspect for wear. Use nonflammable cleaning solutions only if necessary. DO NOT SOAK, which result in o-ring and other parts damage. 	

Fejlfinding • Troubleshooting

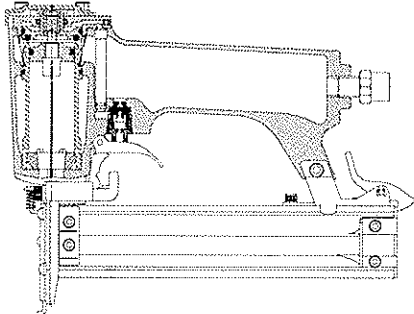
<div style="display: flex; justify-content: space-between;"> <div data-bbox="135 1108 622 1456"> <p>ADVARSEL Repairs other than those described here should be performed only by trained, qualified personnel.</p> <p>WARNING Repairs other than those described here should be performed only by trained, qualified personnel.</p> </div> <div data-bbox="869 1019 1284 1332">  </div> <div data-bbox="662 1388 1420 1489"> <ul style="list-style-type: none"> • Læs "Sikkerhedsbestemmelserne" inden pistolen repareres. • Read section titled "Safety Warnings" before maintaining tool. </div> </div>	
PROBLEMS	SOLUTIONS
<p>1. Der siver luft ud i toppen af pistolen</p> <p>Air leak near top of tool.</p>	<p>Trykluft frakobles. Stram skrueme, der holder endedækslet. Udskift eventuelt hovedstempel.</p> <p>Tighten screws or install head valve piston set.</p>
<p>2. Pistolen kan ikke skyde.</p> <p>Tool does nothing.</p>	<p>Kontroller trykluftstilslutning. Udskift eventuelt hovedstempel efter at trykluft er frakoblet.</p> <p>Verify air supply or install head valve piston set.</p>

<p>3. Pistolen fungerer uregelmæ</p> <p>Sluggish operation.</p>	<p>Kontroller at kompressoren giver det korrekte tryk. Kontroller, at trykluftsslangen har den rigtige diameter og længde. Udskift eventuelt hovedstempel.</p> <p>Install head valve piston set.</p>
<p>4. Der siver luft ud i bunden af pistolen.</p> <p>Air leak near bottom of tool.</p>	<p>Trykluft frakobles. Skrueme strammes. Udskift eventuelt bumper og Stempel-sæt.</p> <p>Tighten screws or install bumper or piston set.</p>
<p>5. Dårlig returbevægelse.</p> <p>Poor return.</p>	<p>Trykluft frakobles. Rengør pistolen. Dryp 2-3 dråber olie i pistolens trykluftskobling. Udskift eventuelt bumper og stempel-sæt.</p> <p>Clean tool and install bumper or piston set.</p>

10

Fejlfinding • Troubleshooting

PROBLEMS	SOLUTIONS
<p>6. Søm/klammer slås ikke helt i.</p> <p>Weak drive.</p>	<p>Kontroller trykluftstilslutningen. Hæv trykket 0,5 bar af gangen. Vigtigt: Max. Tryk må ikke overstiges. Udskift eventuelt stempel-sæt, efter at trykluft er frakoblet.</p> <p>Verify adequate air supply or install piston set.</p>
<p>7. Brækket eller beskadiget slagstift.</p> <p>Broken driver or worn driver.</p>	<p>Trykluft frakobles. Udskift stempel-sæt.</p> <p>Install piston set.</p>
<p>8. Ny klamme/søm bilver ikke ført frem.</p> <p>Poor feed.</p>	<p>Trykluft frakobles. Kontroller, at magasinet ikke er skævt eller ødelagt. Rengør og smør om nødvendigt magasinet. Udskift om nødvendigt fjedrene.</p> <p>Clean tool or lubricate magazine or install spring.</p>

<p>9. Søm/klammer sætter sig fast i pistolen</p> <p>Tool jamming.</p>	<p>Trykluft frakobles. Rengør og smør om nødvendigt magasinet. Udskift om nødvendigt fjedrene.</p> <p>Clean tool or lubricate magazine or install spring.</p>
<p>10. Andre problemer.</p> <p>Other problems.</p>	<p>Kontakt autoriseret forhandler.</p> <p>Contact authorized dealer or distributors.</p>

Reservedelslisten viser alle reservedele. Hard u brug for yderligere informationer, kan du kontakte din forhandler.

For repair kit, please see part list. More informations other than repair kit, contact authorized dealer and distributor.

TEKNISKE DATA

Minimum og maximum arbejdstryk	65-100 psi	4.6-7 BAR
Lufforbrug (60 skud/minut)	0.72scfm	2.6 liter
Lufttilslutning	1/4 in. NPT	1/4 in. NPT
Maximal skudhastighed (skud/sekund)	5	5
Vægt	1.98 lbs.	0.9 kg
Magasinvolumen (stk.)	155	155
Pistolstørrelse: Højde:	5.98 in.	152 mm
Pistolstørrelse: Længde:	8.66 in.	220 mm
Pistolstørrelse: Bredde:	1.69 in.	43 mm
Acceleration :	2.1 M/Sec ²	
Lydniveau (dB) :	89.57	

TECHNICAL SPECIFICATION

Minimum to maximum operating pressure	65-100 psi	4.6-7 BAR
Air consumption (60 cycles per minute)	0.72 scfm	2.6 liter
Air inlet	1/4 in. NPT	1/4 in. NPT
Maximum speed (cycles per second)	5	5
Weight	1.98 lbs.	0.9 kg
Fastener capacity	155	155
Tool size: Height:	5.98 in.	152 mm
Tool size: Length:	8.66 in.	220 mm
Tool size: Width main body	1.69 in.	43 mm
Acceleration	2.1 M/Sec ²	
Noise(dB) :	89.57	

Type 80 klammer

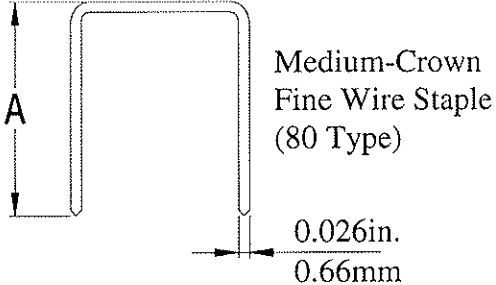

Medium-Crown
Fine Wire Staple
(80 Type)

0.026in.
0.66mm

UM Varenr.	A	
	inches	mm
110406	1/4	6
110408	5/16	8
110410	3/8	10
110412	7/16	11
110414	1/2	13
110416	5/8	16